



# BERETTA



2.5872



2.5975

## MOD. 92 A1 ELECTRIC AIRSOFT / cal. 6 mm BB

**IT** Istruzioni per l'uso 3 - 10

**DE** Bedienungsanleitung 19 - 26

**ES** Manual de instrucciones 35 - 42

**EN** Operating instructions 11 - 18





**FR** Mode d'emploi 27 - 34

Beretta Trademarks licensed by Beretta - Italy - Made for UMAREX - Germany

11R13 © 2013

2.5872 | 2.5975

# INTRODUZIONE | INTRODUCTION | EINLEITUNG | INTRODUCTION | INTRODUCCIÓN

				
<b>IT</b>	Descrizione	Utilizzo	Manutenzione	Norme di sicurezza
<b>EN</b>	Description	Operation	Maintenance	Safety instructions
<b>DE</b>	Benennung	Bedienung	Pflege	Sicherheitshinweise
<b>FR</b>	Désignation des pièces	Emploi	Entretien	Consignes de sécurité
<b>ES</b>	Designación	Reglaje	Cuidados	Instrucciones de seguridad

**FR**

Cette boîte contient: une réplique d'arme factice avec chargeur. Les AIRSOFT GUNS sont des modèles d'armes factices tirant des billes en plastique de 6 mm inoffensives. Ce modèle a une énergie comprise entre 0,08 joule et inférieure ou égale à 2 joules. **En France, la vente de ces produits est réglementée par le décret n°99-240 du 24 mars 1999, qui interdit la distribution des modèles noirs ou chromés dont l'énergie est comprise entre 0,08 et 2 joules aux moins de 18 ans non accompagnés. Ce décret ne concerne pas les modèles transparents, les game guns (oranges) et les mini guns, dont la distribution reste donc autorisée aux mineurs.**

- Distribution et vente interdite aux mineurs.
- Attention: Ne jamais diriger le tir vers une personne.



## UTILIZZO SICURO DELLE ARMI AD ARIA COMPRESSA

IT

È molto importante essere assolutamente certi di quello che si fa quando si maneggia un'arma. Nell'ottica delle norme di base per un utilizzo sicuro delle armi ad aria compressa, ricordate sempre che toccare un'arma, significa contemporaneamente maneggiarla.

- Trattate l'arma sempre come se fosse carica.
- Quando caricate l'arma, attivate sempre la sicura per evitare che involontariamente parta un colpo. Tenete il dito sempre al di fuori del ponticello, fino all'attimo prima di sparare.
- Utilizzate solo i proiettili indicati per quest'arma.
- Indirizzate l'arma sempre in una direzione sicura.
- Il tiro è ammesso soltanto all'interno della propria abitazione, in poligoni abilitati dalle autorità di polizia e su terreni che non possano essere oltrepassati dal proiettile. Considerate la portata massima del proiettile.
- Non trasportate mai un'arma carica. Caricatela soltanto se volete sparare.
- Non indirizzate mai l'arma verso persone o animali. Controllate che il proiettile non possa rimbalzare. Non sparate mai su superfici lisce, dure o sull'acqua.
- Accertatevi prima di sparare della sicurezza del bersaglio e delle sue immediate vicinanze.
- Controllate sempre se l'arma è scarica prima di trasportarla o prima di prenderla in consegna da un'altra persona.
- Tenete l'arma in modo da poterne controllare la direzione della volata anche se inciampate o state cadendo.
- Per motivi di sicurezza consigliamo di portare occhiali di protezione durante il tiro.
- Conservate e riponete al sicuro l'arma sempre scarica e al di fuori dalla portata di persone non autorizzate (inesperti, bambini) e separata dalle munizioni.
- Affidate quest'arma, insieme con le istruzioni d'uso, esclusivamente a persone
  - che hanno perfetta dimestichezza con il maneggio di quest'arma, e
  - che hanno raggiunto l'età minima legale secondo la legge sulle armi in vigore nel vostro paese.
- Qualsiasi modifica o riparazione dell'arma deve essere effettuata esclusivamente da ditte o armaioli specializzati.
- Non lasciate mai incustodita l'arma carica.
- Scaricate la vostra arma prima di consegnarla ad altre persone.

## RIPARAZIONE

Un'arma che non funziona perfettamente è pericolosa. È molto difficile riparare autonomamente un'arma, e un assemblaggio non corretto può determinare pericolosi malfunzionamenti.

**Attenzione: Fare verificare e riparare l'arma soltanto da rivenditori specializzati / armaioli autorizzati.**



## NORME DI SICUREZZA | GARANZIA

IT



### ATTENZIONE

Raccomandiamo, per la vostra e per l'altrui sicurezza, di leggere attentamente e completamente le istruzioni per l'uso prima di effettuare qualsiasi prova di sparo con quest'arma. L'acquirente ed il detentore hanno l'obbligo di seguire tutte le regole per il possesso e l'utilizzo di pistole ad aria compressa. Qualsiasi modifica a quest'arma può portare a una variazione della classificazione secondo le norme sul possesso e sull'uso delle armi, pertanto non è ammessa. In questo caso la garanzia del produttore decade con effetto immediato.



### AVVERTIMENTO

Non agitare o brandire minacciosamente questa arma in pubblico - essa potrebbe essere considerata un'arma da fuoco vera e propria, cosa che costituisce un delitto. Non modificare in nessun caso il colore e le marcature dell'arma nell'intento di farla assomigliare ad una reale arma da fuoco. Un'operazione di questo tipo è pericolosa e può costituire un reato.

## GARANZIA

Entro un anno dalla data di acquisto, la ditta UMAREX procede gratuitamente alla riparazione o sostituzione dell'arma, a condizione che il difetto non sia imputabile all'utilizzatore. Affidate l'arma ad un rivenditore autorizzato, descrivete il problema e consegnate la prova di acquisto. Le armi ad aria compressa prodotte dalla ditta UMAREX Sportwaffen GmbH & Co. KG vengono costruite in conformità ai requisiti di certificazione dell'Ente federale fisico-tecnico (Physikalisch-Technische Bundesanstalt PTB), alle leggi federali, alla normativa CIP e in base al know how acquisito dalla ditta UMAREX Sportwaffen GmbH & Co. KG nella fabbricazione di armi sportive. In caso di esportazione all'estero, il produttore declina qualsiasi responsabilità per la non conformità dell'arma alle norme vigenti nel paese di destinazione nonché per eventuali difficoltà giuridiche e le relative conseguenze che ne potrebbero risultare per il proprietario/l'acquirente.

## DATI TECNICI

Codice art.	2.5872 Mod. 92 A1	2.5975 Mod. 92 A1 Tactical
Sistema	Electric Airsoft	
Calibro/Munizione	cal. 6 mm BB	
Energia	< 0,5 JOULE	
Velocità del proiettile	fino a 60 m/s con BB 0,20 g	
Capacità	30 BBs	
Azione	Effetto singolo	
Mira	Mirino e tacca di mira fissi	
Sicura	manuell	
Peso	568 g	665 g
Lunghezza canna	125 mm	
Lunghezza	219 mm	
Lunghezza con Silenziatore fittizio	-	345 mm
Distanza di pericolo	150 m	



## DESCRIZIONE

IT





## SICURA

IT



### ATTENZIONE

- Accertarsi che la sicura sia inserita prima di iniziare a maneggiare l'arma.
- Indirizzare l'arma sempre in una direzione sicura.



## PROBLEMI



### Possibili cause

#### Problemi

Problemi	Sicura attivata	Caricatore vuoto	Canna sporca internamente	Temperature estreme	Munizione sbagliata	Munizione caricata in maniera errata	Otturatore non chiuso	Dispositivo di mira non regolato correttamente
L'arma non spara		●	●	●	●	●		●
Scarsa precisione	●	●			●	●	●	
Velocità ridotta del proiettile		●	●	●	●	●		



## CARICATI

IT



### ATTENZIONE

- Accumulatori quasi esauriti possono causare avarie alla gearbox che necessitano di riparazione.
- Gli accumulatori non devono venire scaricati eccessivamente perché gli elementi possono venire danneggiati.
- Un sovraccaricamento prolungato causa danni duraturi agli accumulatori.
- Prima di venire caricati, gli accumulatori dovrebbero essere completamente scarichi.
- Gli accumulatori non sottostanno ad alcuna garanzia in quanto soggetti a logoramento.



### ATTENZIONE



**Indicazioni sulle batterie:** Le batterie non devono essere sottoposte a fonti di calore eccessivo, come p.e. luce solare, fuoco o simili. Ricaricare solo le batterie ricaricabili. Le batterie usate non devono, per legge, essere smaltite con i comuni rifiuti domestici. Le batterie scariche devono essere consegnate gratuitamente presso i centri di raccolta autorizzati, nei punti vendita o presso il nostro centro di assistenza tecnica. Le batterie e gli accumulatori usati presentano un'alta percentuale di materiali recuperabili. La possibilità di recuperare tali materiali con il processo di riciclaggio, permette di contribuire a preservare importanti risorse e a proteggere l'ambiente da dannosi metalli pesanti. Le batterie che contengono sostanze nocive sono contrassegnate da un simbolo rappresentante un bidone dei rifiuti sbarato con una X e dal simbolo chimico (Cd, Hg o Pb) del metallo pesante inquinante che contengono. Informarsi presso gli enti locali sui centri di raccolta per lo smaltimento. Le indicazioni per la rimozione delle batterie sono contenute nel manuale del prodotto.

Le batterie primarie e secondarie al litio Smaltire solo batterie completamente scariche. Se le batterie non sono completamente scariche, prendere provvedimenti atti ad evitare un corto circuito (p.e. isolare gli elettrodi).

**Tempo di caricamento: 2,25 ore.**

**Nota: Accumulatore fisso (7,2 V / 300 mAh), con alimentatore in dotazione.**



Premere il pulsante del caricatore. Rimuovere il caricatore.



Introdurre la spina come raffigurato.





## CARICARE IL CARICATORE

IT

### ATTENZIONE



Utilizzare solo BB senza difetti:  $\varnothing$  6 mm.

In ogni caso non usare mai i seguenti BB:

1 con diametro maggiore di 6 mm, 2 con spigoli vivi, 3 con metà sfalsate, 4 usati, sporchi. L'uso di proiettili non adatti fa decadere la garanzia. Si consigliano proiettili di precisione del produttore UMAREX/WALTHER. Evitare la penetrazione di sporco e polvere nel caricatore.



1. Premere il pulsante del caricatore. Rimuovere il caricatore.

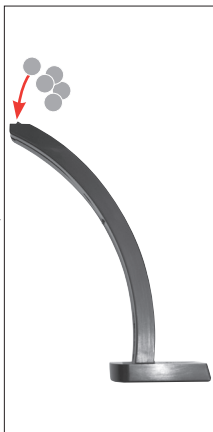

Caricare i BB.



Inserire il caricatore.





## DISPOSITIVO DI MIRA

IT

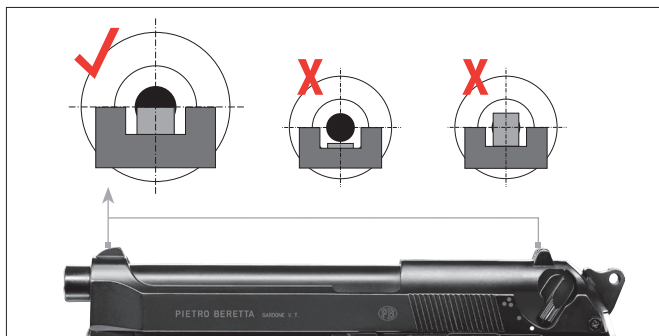

## TIRO





## MONTAGGIO DI ACCESSORI

IT

### MONTAGGIO SILENZIATORE FITIZIO



Per montare il silenziatore fittizio ruotarlo in senso antiorario.



Per smontare il silenziatore fittizio ruotarlo in senso orario.



### PULIZIA DELLA CANNA



#### ATTENZIONE

- Prima di pulire l'arma, scaricarla.
- Non forzare mai l'asta all'interno della canna per evitare di danneggiarla.
- Ripulire di tanto in tanto le parti metalliche esterne. Servirsi a tale scopo di uno straccio leggermente imbevuto di olio per armi.
- Non introdurre mai l'olio per armi direttamente nella canna.

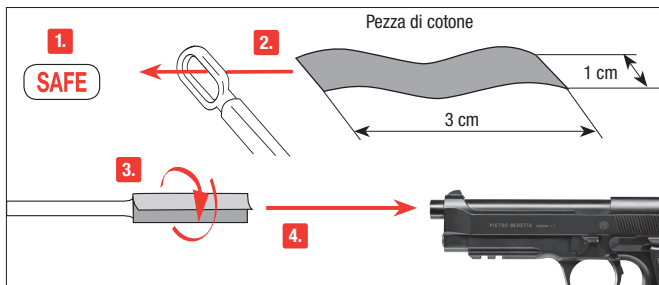

Attivare la sicura prima di procedere alla pulizia. Usare un'asta sottile lunga circa 30 cm. Avvolgere una pezza di cotone intorno alla sua estremità, inumidire leggermente la pezza con olio per armi e pulire la canna.



## SAFE GUN HANDLING

EN

You should be fully familiar with the proper and safe handling of your gun. The basic principles of gun safety require you to always apply the following rules when handling the firearm.

- Always treat a gun as if it was loaded.
- Always put the safety of a gun to “safe” when loading it so that there can be no unintentional discharge.
- Keep your finger away from the trigger. It should be straight and should rest on the trigger guard.
- Only use the kind of projectiles suitable for your gun.
- Always keep the muzzle pointed in a safe direction.
- This gun may only be discharged in your own house, on authorized shooting ranges and inside enclosed private property. It is to be made sure that no projectile can leave the enclosed property.
- Keep the danger area of the projectile in mind.
- Never transport a loaded gun. Only load your gun when you intend to fire it.
- Never aim your airgun at persons or animals. Avoid ricochets. Never fire at smooth, hard surfaces or water.
- Before you discharge your gun, make sure that target and surrounding area are safe.
- Make sure that you always have full control over the muzzle of your gun, even if you stumble or fall down.
- Safety shooting glasses should always be worn when firing the gun.
- Always store your gun in a safe place and in unloaded condition. Unauthorized persons (persons not familiar with the use of guns, children) must not have access to it. Ammunition is to be kept in a separate place.
- This gun and its instruction manual may only be passed on to persons
  - who are fully familiar with its use and
  - who have reached the legally stipulated minimum age in the respective country.
- Modifications or repairs of guns are only to be effected by authorized agencies or by a skilled gunsmith.
- Never leave a loaded gun unattended.
- Only unloaded guns are to be handed over to another person.

## REPAIR

Do not attempt to repair this pistol if it needs service. Incorrect assembly could lead to dangerous malfunctions.

**Caution: Repairs should only be completed by UMAREX authorized centres.**



## SAFETY INSTRUCTIONS | WARRANTY

EN



### CAUTION

For your own safety and the safety of others, carefully read these instructions before using this gun. Buyers and owners must observe all rules concerning the use and ownership of air guns. Modifying this gun may result in a change of its classification under guns law and is therefore prohibited. In such cases the manufacturer's warranty will immediately become void.



### WARNING

Do not brandish or display this airgun in public - it may confuse people and may be a crime. Police and others may think this airgun is a firearm. Do not change the coloration and markings to make it look more like a firearm. That is dangerous and may be a crime.

## WARRANTY

During the legal warranty period, which begins on the date of purchase, UMAREX will repair or replace your gun at no charge provided the defect was not caused by you. Return your gun to an authorized dealer along with a description of the problem and proof of purchase.

The air guns manufactured by UMAREX Sportwaffen GmbH & Co. KG are made according to the regulations of the PTB (Physikalisch-Technische Bundesanstalt), German federal law, the CIP regulations and the technical know-how of UMAREX Sportwaffen GmbH & Co. KG.

We will not assume any liability whatsoever if this product is exported to territories outside of Germany and as a consequence does not comply with domestic legal requirements of these territories. It will be the sole responsibility of the importer to ensure compliance with local laws and regulations.

## TECHNICAL DATA

Item no.	2.5872 Mod. 92 A1	2.5975 Mod. 92 A1 Tactical
System	Electric Airsoft	
Caliber / ammo	cal. 6 mm BB	
Energy	< 0,5 JOULE	
Velocity	up to 60 m/s with 0.20 g BB	
Magazine capacity	30 BBs	
Trigger	Single action	
Sights	fixed front and rear	
Safety	manual	
Weight	568 g	665 g
Barrel length	125 mm	
Length	219 mm	
Length with mock suppressor	-	345 mm
Danger distance	150 m	



## DESCRIPTION

EN





## SAFETY

EN



### CAUTION

- Only handle your gun in its safe condition.
- Always make sure that the muzzle points in a safe direction.



## PROBLEM SOLUTIONS



### Possible causes

#### Problems

Problems	Safety activated	Magazine empty	Dirty barrel	Extreme temperatures	Wrong ammunition	Ammunition badly loaded	Slide not decocked	Sight not properly adjusted
Faulty shooting direction		●	●	●	●	●		●
Weapon does not shoot	●	●			●	●	●	
Low shooting speed		●	●	●	●	●		



## CHARGING

EN



### CAUTION

- When batteries are almost empty they can cause gearbox malfunctions that require repair.
- Batteries should never be overdischarged. This can damage the cell.
- Prolonged overcharging causes permanent damage to batteries.
- The battery should always be drained before charging.
- There is no warranty for batteries, because they are wear parts.



### CAUTION



**Notes on batteries:** Batteries must not be exposed to excessive sources of heat such as sunshine, fire or similar. Only rechargeable batteries may be charged. It is unlawful to dispose of used batteries along with common household waste. You are obligated to dispose of old batteries (free of charge) at a public collection point, a business which will accept their return or at a technical customer service location. Used primary and secondary (rechargeable) batteries contain high percentages of reusable substances, so-called "recoverable resources". By ensuring their recovery through appropriate recycling processes instead of combining them with common waste materials, you make a contribution in preserving important resources and protecting the environment from harmful heavy metal substances. Batteries containing pollutants are marked with the symbol of a crossed-out garbage can and a chemical symbol (Cd, Hg or Pb) which is essential for classification of the polluting heavy metal. Please contact your local authorities for information about disposal facilities.

For lithium-based primary and secondary batteries: Only dispose of completely discharged batteries. If a battery is not completely discharged, precautions must be taken to prevent short circuiting its terminals, e.g. isolation of the terminals.

The charging time is 2.25 h.

**Note: Battery (7.2 V/300 mAh) is permanently installed. Power adapter included.**



Press magazine release  
Remove the magazine.



Current line mounted how pictured.





## LOADING THE MAGAZINE

EN

### CAUTION



**Only use flawless BBs: Never use the following BBs:**

1 diameter larger than 6mm, 2 with edges, 3 both halves not aligned, 4 used, soiled.

Warranty expires if non-recommended BBs are used.

It's recommended to use precision BBs from UMAREX/WALTHER.

To ensure proper operation of the magazine, protect it from dirt and dust.



Press magazine release  
Remove the magazine

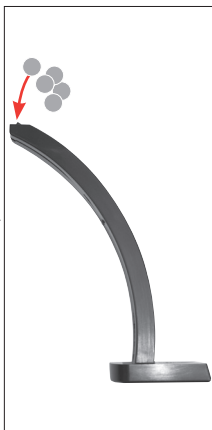

Load BBs.



Insert magazine.





## SIGHTS

EN

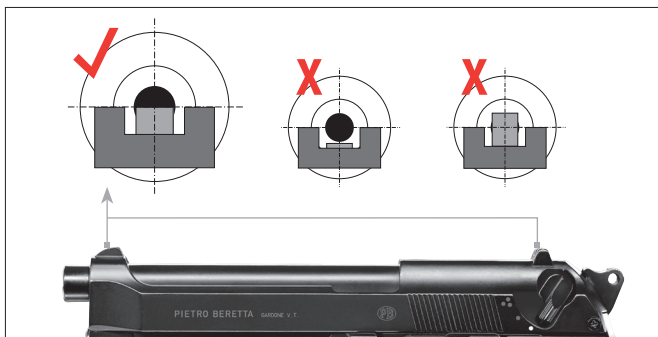

## SHOOTING





## MOUNTING OF ACCESSORIES

EN

### MOUNTING OF MOCK SUPPRESSOR

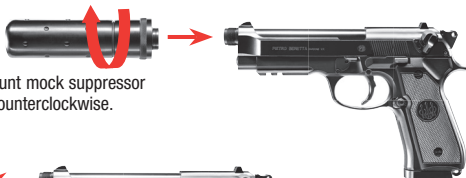

To mount mock suppressor turn counterclockwise.

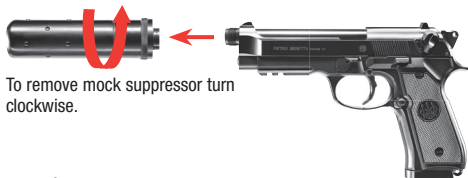

To remove mock suppressor turn clockwise.



### BARREL CLEANING



#### CAUTION

- Unload the gun before cleaning the gun.
- Do not force the rod into the barrel, as this could cause damage.
- Occasionally clean the metal parts on the outside. Use a cloth which has been slightly dampened with some gun oil.
- Never drip silicone oil directly into the barrel.

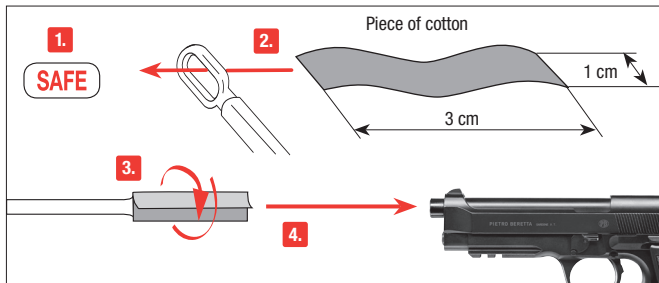



Put the safety on "safe". Prepare a thin rod with a length of approx. 30 cm. Attach a piece of cotton fabric to its end and clean the barrel with some silicone oil.



## SICHERER UMGANG MIT WAFFEN

DE

Sie sollten mit der richtigen, sicheren Handhabung Ihrer Waffe vertraut sein. Im Hinblick auf die Grundregeln zum sicheren Schießen bedenken Sie, dass jede Berührung mit der Waffe als Handhabung verstanden wird.

- Behandeln Sie jede Waffe so, als wäre sie geladen.
- Die Waffe beim Laden stets sichern, so dass sich kein Schuss ungewollt lösen kann. Finger immer außerhalb des Abzugsbügels halten und nur zum Schuss an den Abzug legen.
- Verwenden Sie nur für diese Waffe vorgesehene Geschosse.
- Halten Sie die Mündung stets in eine sichere Richtung.
- Das Schießen ist nur in der eigenen Wohnung, auf polizeilich zugelassenen Schießständen und im befriedeten Besitztum erlaubt, wenn das Geschoss dieses beim Schuss nicht verlassen kann. Hierbei den Gefahrenbereich des Geschosses beachten.
- Transportieren Sie niemals eine geladene Waffe. Laden Sie nur, wenn Sie schießen möchten.
- Waffe niemals auf Menschen oder Tiere richten. Vermeiden Sie Querschläger. Schießen Sie niemals auf glatte, harte Oberflächen oder auf Wasserflächen.
- Vergewissern Sie sich vor dem Schuss, dass Ziel und Umgebungsbereich sicher sind.
- Kontrollieren Sie immer, ob die Waffe ungeladen ist, wenn Sie sie transportieren oder von einer anderen Person übernehmen.
- Vergewissern Sie sich, dass Sie auch beim Stolpern oder Stürzen die Richtung der Mündung kontrollieren können.
- Aus Sicherheitsgründen sollte beim Schießen eine Schutzbrille getragen werden.
- Aufbewahren der Waffe stets sicher und ungeladen vor unerlaubtem Zugriff Unbefugter (ungeschulte Personen, Kinder, Personen unter 18 Jahren) und getrennt von der Munition.
- Weitergabe dieser Waffe mit der Bedienungsanleitung nur an Personen
  - die mit der Handhabung dieser Waffe genauestens vertraut und bei Waffen mit -Zeichen mindestens 18 Jahre alt sind.
- Druckluftwaffen mit Energie > 0,5 Joule aber ohne -Zeichen sind erwerbscheinpflichtig.
- Jegliche Veränderungen oder Reparaturen von Waffen sollten nur von fachkundigen Firmen oder vom Büchsenmacher durchgeführt werden.
- Legen Sie niemals eine geladene Waffe aus der Hand.
- Geben Sie nur entladene Waffen an andere Personen weiter.

## REPARATUR

Eine Waffe, die nicht einwandfrei funktioniert, ist gefährlich. Es ist schwierig, eine Waffe selbst zu reparieren, und falscher Zusammenbau kann zu gefährlichen Funktionsstörungen führen.

**Achtung: Lassen Sie die Waffe nur von einem autorisiertem Fachhändler/  
Büchsenmacher überprüfen und reparieren.**



## SICHERHEITSHINWEISE | GARANTIE

DE



### ACHTUNG

Zu Ihrer eigenen und zur Sicherheit anderer lesen Sie die Bedienungsanleitung vollständig und sorgfältig durch, bevor Sie mit der Waffe erstmalig hantieren. Käufer und Besitzer haben die Pflicht, alle Regeln über den Gebrauch und den Besitz von Druckluftwaffen zu befolgen. Jede Änderung an dieser Waffe kann zu einer Änderung der waffenrechtlichen Einstufung führen und ist somit unzulässig. Die Gewährleistung des Herstellers erlischt in diesem Fall sofort.



### WARNUNG

Diese Druckluftwaffe nicht in der Öffentlichkeit zeigen oder mit ihr drohen – es führt zu Verwechslungen mit echten Waffen und gilt als Straftat. Ändern Sie keinesfalls die Farbe und Markierungen der Druckluftwaffe, um ihr Aussehen mehr einer realen Schusswaffe anzugleichen. Dies ist gefährlich und gilt als Straftat.

## GARANTIE

Innerhalb des gesetzlich festgelegten Zeitraumes ab Kaufdatum repariert oder ersetzt Ihnen die Fa. UMAREX Ihre Waffe kostenlos, falls der Defekt nicht durch Eigenverschulden aufgetreten ist. Geben Sie die Waffe einem autorisierten Händler, beschreiben Sie ihm das Problem und fügen Sie den entsprechenden Kaufbeleg bei.

Die von UMAREX Sportwaffen GmbH & Co. KG hergestellten Druckluftwaffen werden gemäß den Zulassungsvorschriften der Physikalisch-Technischer Bundesanstalt (PTB), dem Bundesgesetz, den CIP-Vorschriften und dem waffentechnischen Know-how der Firma UMAREX Sportwaffen GmbH & Co. KG hergestellt.

Somit übernehmen wir keine Haftung, falls diese Ware nach dem Export ins Ausland nicht den dort geltenden Rechtsvorschriften entsprechen sollte und dem Besitzer/Käufer juristische Schwierigkeiten und Konsequenzen daraus entstehen sollten.

## TECHNISCHE DATEN

Art. Nr.	2.5872 Mod. 92 A1	2.5975 Mod. 92 A1 Tactical
System	Electric Airsoft	
Kaliber/Munition	cal. 6 mm BB	
Energie	< 0,5 JOULE	
Geschossgeschwindigkeit	bis 60 m/s mit 0,20 g BB	
Magazinkapazität	30 BBs	
Abzug	Single Action	
Visierung	Kimme und Korn fest	
Sicherung	Manuell	
Gewicht	568 g	665 g
Lauflänge	125 mm	
max. Gesamtlänge	219 mm	
Länge mit Schalldämpferatrappe	-	345 mm
Gefahrenbereich max.	150 m	



## BENENNUNG

DE





## SICHERUNG

DE



### ACHTUNG

- Hantieren Sie nur mit der Waffe, wenn diese gesichert ist.
- Achten Sie stets darauf, dass die Mündung in eine sichere Richtung zeigt.



## PROBLEMLÖSUNGEN



### Probleme

### Mögliche Gründe

Probleme	Waffe gesichert	Magazin leer	Lauf verschmutzt	Extreme Temperaturen	Falsche Munition	Munition falsch geladen	Schlitten nicht entrastet	Visierung nicht richtig eingestellt
schlechte Schussleistung		●	●	●	●	●		●
Waffe schießt nicht	●	●			●	●	●	
geringe Geschwindigkeit		●	●	●	●	●		



## AKKU AUFLADEN

DE



### ACHTUNG

- Bei fast leeren Akkus kann es zu Gearbox-Störungen kommen, welche reparaturbedürftig sind.
- Akkus dürfen nicht tiefentladen werden, sonst können die Zellen beschädigt werden.
- Längeres Überladen verursacht dauerhaften Schaden der Akkus.
- Akkus sollten vor dem Laden stets entladen sein.
- Auf Akkus kann keine Garantie gewährt werden, da sie Verschleißteile sind.



### ACHTUNG



**Hinweise zu Batterien:** Batterien dürfen nicht übermäßiger Wärme ausgesetzt werden, wie Sonnenschein, Feuer oder dergleichen. Nur wiederaufladbare Batterien dürfen geladen werden. Verbrauchte Batterien dürfen laut Gesetzgeber nicht in den Hausmüll entsorgt werden. Sie sind verpflichtet sie bei einer öffentlichen Sammelstelle für Altbatterien, in einer Verkaufsstelle oder beim technischen Kundendienst kostenfrei abzugeben. Gebrauchte Batterien und Akkus weisen einen hohen Anteil an wieder verwertbaren Materialien, so genannten Wertstoffen auf. Dadurch, dass sie im Recyclingprozess zurück gewonnen werden, statt in den Abfall zu gelangen, leisten Sie einen Beitrag zur Erhaltung wichtiger Ressourcen und Sie schützen die Umwelt vor schädlichen Schwermetallen. Schadstoffhaltige Batterien sind mit einem Zeichen, bestehend aus einer durchgestrichenen Mülltonne und dem chemischen Symbol (Cd, Hg oder Pb) des für die Einstufung als schadstoffhaltig ausschlaggebenden Schwermetalls versehen. Informieren Sie sich bitte bei Ihrer Gemeinde über entsprechende Entsorgungseinrichtungen. Für Lithium-basierte Primär- und Sekundärbatterien: Nur vollständig entladene Batterien entsorgen. Falls die Batterie nicht vollständig entladen ist müssen Vorkehrungen zur Sicherung gegen Kurzschluss getroffen werden, z.B. Isolierung der Elektroden.

Die Aufladezeit beträgt 2,25 h.

Hinweis: Festeingebauter Akku (7,2 V / 300 mAh) inkl. Netzteil.



Magazinhalter drücken.  
Magazin entnehmen.



Stecker wie abgebildet einführen.





## MAGAZIN LADEN

DE



### ACHTUNG



Verwenden Sie nur einwandfreie BB-Kugeln:  $\varnothing$  6 mm.

Verwenden Sie auf keinen Fall folgende BB-Kugeln:

1 Durchmesser größer als 6 mm, 2 mit Grat, 3 versetzte Hälften, 4 gebraucht, verschmutzt. Bei Gebrauch ungeeigneter Geschosse erlischt die Garantie. Empfohlen werden Präzisionsrundkugeln des Herstellers UMAREX/WALTHER. Vermeiden Sie das Eindringen von Schmutz und Staub in das Magazin.



Magazinhalter drücken.  
Magazin entnehmen.

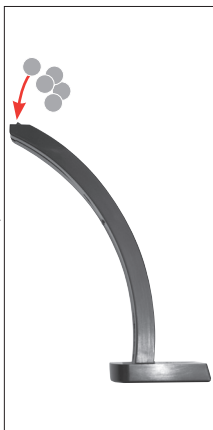

BBs laden.



Magazin einsetzen.





## VISIERUNG

DE

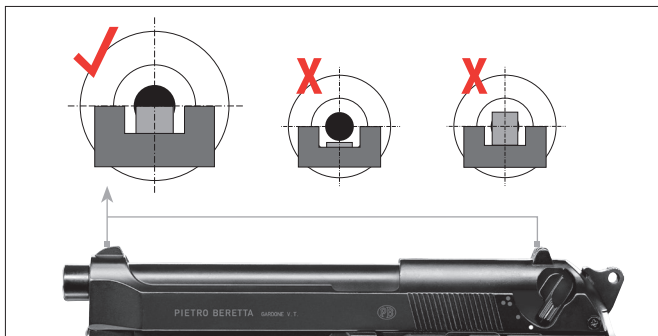

## SCHIESSEN





## MONTAGE DES ZUBEHÖR

DE

### MONTAGE DER SCHALLDÄMPFERATTRAPPE



Zum Montieren der Schalldämpferattrappe gegen den Uhrzeigersinn drehen.



Zum Abmontieren der Schalldämpferattrappe mit dem Uhrzeigersinn drehen.



### LAUFREINIGUNG



### ACHTUNG

- Entladen Sie die Waffe bevor Sie die Waffe reinigen.
- Schieben Sie den Stab niemals mit Gewalt in den Lauf, dies kann Beschädigungen verursachen.
- Reinigen Sie gelegentlich die äußeren Metallteile. Benutzen Sie dazu ein Tuch, auf das Sie leicht Waffenöl aufgetragen haben.
- Geben Sie niemals das Waffenöl direkt in den Lauf.

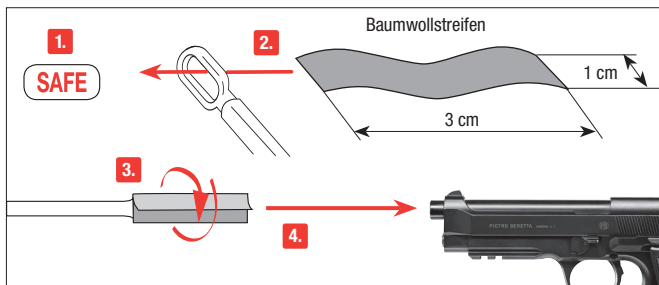

Sichern Sie die Waffe. Nehmen Sie einen ca. 30 cm dünnen, langen Stab. Wickeln Sie ein Stück Baumwolltuch um das Ende, benetzen Sie das Tuch mit etwas Waffen-Öl und reinigen Sie damit den Lauf.



## MANIEMENT DES ARMES EN TOUTE SÉCURITÉ

FR

Vous devez savoir manier votre arme correctement et de manière sûre et devez impérativement respecter les règles de base de tir en toute sécurité à chaque fois que vous manipulez l'arme.

- Maniez toujours l'arme comme si elle était chargée.
- Mettez toujours la sûreté avant de charger l'arme afin d'éviter tout tir involontaire.
- Ne mettez pas le doigt sur la détente et ne l'y placez que lorsque vous allez tirer.
- N'utilisez que les projectiles prévus pour cette arme.
- Pointez toujours la bouche de l'arme dans une direction non dangereuse.
- Il n'est permis de tirer avec l'arme que sur le lieu de résidence du propriétaire ou dans des zones de tir autorisées par la police, à condition que le projectile ne puisse pas sortir de la zone de tir. Veuillez toujours prendre en compte la zone de danger maximale du projectile.
- Ne transportez jamais l'arme lorsqu'elle est chargée. Ne la chargez que lorsque vous vous apprêtez à tirer.
- Ne dirigez jamais l'arme vers des personnes ni des animaux. Évitez les tirs pouvant faire ricocher le projectile. Ne tirez jamais sur des surfaces planes et dures, ni sur une surface d'eau car les projectiles peuvent ricocher.
- Avant de tirer, assurez-vous que l'objectif et les alentours ne présentent pas de danger.
- Vérifiez toujours que l'arme est déchargée avant de la transporter ou de la remettre à autrui.
- Veillez à maîtriser la direction dans laquelle la bouche de l'arme est pointée, même si vous trébuchez ou tombez.
- Pour des raisons de sécurité, portez des lunettes de protection lorsque vous tirez.
- Rangez toujours l'arme déchargée, séparée des munitions et dans un endroit sûr afin d'éviter que des personnes non autorisées (personnes non formées, enfants) puissent y avoir accès.
- Ne remettez cette arme, accompagnée du mode d'emploi, qu'à des personnes
  - qui sont le plus possible formées au maniement de cette arme et
  - qui ont atteint l'âge minimum légal selon la loi sur les armes en vigueur dans votre pays.
- Toute modification ou réparation de l'arme devra être effectuée par une entreprise spécialisée ou un armurier.
- Ne laissez jamais l'arme chargée sans surveillance.
- Déchargez toujours l'arme avant de la remettre à autrui.

## RÉPARATIONS

Une arme qui ne fonctionne pas parfaitement est dangereuse. Il est difficile de réparer une arme soi-même, et un remontage incorrect peut entraîner des dysfonctionnements dangereux. **Attention : seules des personnes spécialisées agréées ou un armurier peuvent contrôler et réparer l'arme.**



## CONSIGNES DE SÉCURITÉ | GARANTIE

FR



### ATTENTION

Pour votre sécurité et celle d'autrui, lisez attentivement la notice d'emploi avant d'utiliser l'arme pour la première fois. Les vendeurs, tout comme les acheteurs, ont l'obligation de respecter le règlement relatif à l'utilisation et à la possession d'armes à air comprimé.

Il est interdit de procéder à toute modification de ce pistolet car cela pourrait entraîner un changement dans la classification correspondant à la législation sur les armes à feu. De plus, toute modification entraînerait l'annulation immédiate de la garantie du fabricant.



### MISE EN GARDE

Mise en garde: N'exhibez pas cette arme à air comprimé et ne la sortez pas en public. Cela pourrait prêter à confusion ou être considéré comme un délit. Les membres des forces de sécurité et la police pourraient la prendre pour une vraie arme à feu. Ne changez pas sa couleur ni les éléments d'identification pour qu'elle ressemble plus à une vraie arme à feu. Cela serait dangereux et peut être considéré comme un délit.

## GARANTIE

La société UMAREX s'engage à réparer ou à remplacer votre arme durant une période déterminée légalement à compter de la date d'achat, à condition que vous ne soyez pas responsable du défaut. Pour cela, remettez l'arme à un revendeur autorisé, décrivez-lui le problème et joignez le justificatif d'achat correspondant.

Les armes à air comprimé de la société UMAREX Sportwaffen GmbH & Co. KG sont fabriquées conformément aux directives de conformité de l'institut allemand « Physikalisch-Technische Bundesanstalt (PTB) », à la loi fédérale, aux prescriptions CIP et au savoir-faire technique de la société UMAREX Sportwaffen GmbH & Co. KG dans le domaine des armes.

Ainsi, nous ne pouvons être tenus responsables si, après exportation à l'étranger, cette marchandise ne répond pas aux prescriptions légales en vigueur dans le pays en question et si le possesseur/acheteur doit pour cette raison faire face à des difficultés juridiques ou toute autre conséquence pouvant découler de ce fait.

## DONNÉES TECHNIQUES

Numéro d'article	2.5872 Mod. 92 A1	2.5975 Mod. 92 A1 Tactical
Système	Airsoft électrique	
Calibre / Munitions	Billes BB cal. 6 mm	
Énergie	< 0,5 JOULE	
Vitesse	jusque 60 m/s avec billes BB 0,20 g	
Capacité du chargeur	30 billes BB	
Détente	action simple	
Dispositif de visée	guidon et hausse fixe	
Sécurité	Manuell	
Poids	568 g	665 g
Longueur canon	125 mm	
Longueur	219 mm	
Longueur avec Silencieux factice	-	345 mm
Zone de danger	150 m	



## DÉSIGNATION DES PIÈCES

FR





## SÛRETÉ

FR



### ATTENTION

- Ne manipulez l'arme que lorsque la sûreté est enclenchée.
- Assurez-vous que la bouche est orientée dans une direction non dangereuse.



## DYSFONCTIONNEMENTS



### Dysfonctionnements

### Causes possibles

Dysfonctionnements	sûreté de l'arme enclenchée	chargeur vide	canon encrassé	températures extrêmes	mauvaises munitions	munitions mal chargées	culasse non fermée	dispositif de visée mal réglé
mauvaise performance de tir		●	●	●	●	●		●
l'arme ne tire pas	●	●			●	●	●	
faible vitesse du projectile		●	●	●	●	●		



## CHARGEMENT

FR



### ATTENTION

- Si les accus sont presque vides, des perturbations au niveau de la transmission pourraient en résulter qui rendent nécessaire une réparation.
- Il ne faut pas décharger complètement les accus. Sinon, les cellules risquent d'être abîmées.
- Toute surcharge de longue durée est susceptible d'abîmer les accus durablement.
- Avant tout chargement, il faudrait que les accus soient toujours déchargés.
- Nous ne pouvons pas accorder de garantie pour les accus, car ceux-ci représentent des pièces d'usure.



### ATTENTION



**Remarques concernant les piles :** Ne pas exposer les piles à une source de chaleur trop importante, comme par exemple aux rayons du soleil, au feu ou semblables. Ne recharger que des piles rechargeables. La loi interdit de jeter les piles usées dans les ordures ménagères. Vous êtes tenus de les rapporter à un centre public de collecte des piles usagées, à un lieu de vente ou au service après-vente technique où elles sont récupérées à titre gratuit. Les piles et accus usagés contiennent un haut pourcentage de matériaux valorisables également appelés matériaux recyclables. Étant donné que ces matériaux sont récupérés pendant le processus de recyclage au lieu d'être éliminés avec les autres déchets, vous contribuez à conserver des ressources importantes et protéger l'environnement des métaux lourds toxiques et nocifs pour l'environnement. Les piles contenant des produits toxiques sont identifiées par un symbole représentant une poubelle barrée et le symbole chimique du métal lourd (Cd, Hg ou Pb) décisif pour la classification comme contenant des produits toxiques. Veuillez vous renseigner auprès de votre commune sur les points de collecte appropriés. Consultez le manuel du produit pour savoir comment enlever les piles. Pour les piles primaires et secondaires à base de lithium : Ne mettre au rebut que des piles entièrement déchargées. Si la pile n'est pas entièrement déchargée, il est nécessaire de prendre des mesures préventives afin de la protéger de tout court-circuit, par ex. par une isolation des électrodes.

**Le temps de charge s'élève à 2,25 h.**

**Remarque : accu intégré fixe (7,2 V/300 mAh) avec bloc d'alimentation.**



Appuyez sur l'arrêt de chargeur. Retirez le chargeur.



Introduire la ligne comme illustré.





## CHARGEMENT BILLES BB

FR



### ATTENTION



N'utilisez que des billes BB (sans défaut).

N'utilisez jamais les types de billes BB suivants:

① Diamètre supérieur à 6 mm, ② Ebréchées, ③ Dont les moitiés ne coïncident pas, ④ Usées ou sales. Si des projectiles autres que ceux appropriés sont utilisés, la garantie ne sera plus valable. Il est recommandé d'utiliser des billes de précision de la marque UMAREX/WALTHER. Pour garantir le bon fonctionnement du chargeur, faites en sorte que les saletés et poussières n'entrent pas dans le chargeur.



Appuyez sur l'arrêt du chargeur. Retirez le chargeur.

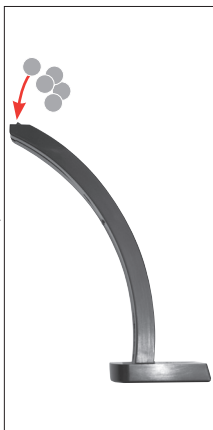

Introduisez BBs.



Poussez le chargeur.





## DISPOSITIF DE VISÉE

FR

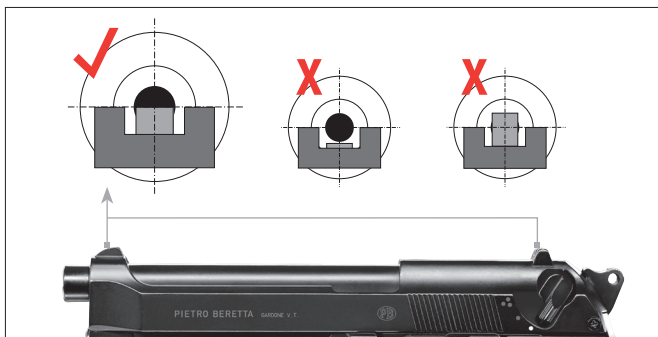

## TIR





## MONTAGE DES ACCESSOIRES

FR

### MONTAGE SILENCIEUX FACTICE

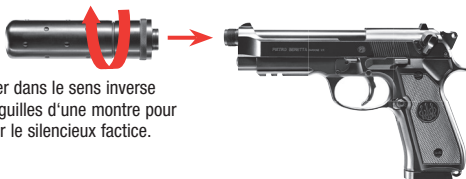

Tourner dans le sens inverse des aiguilles d'une montre pour monter le silencieux factice.



Tourner dans le sens des aiguilles d'une montre pour démonter le silencieux factice.



### NETTOYAGE LE CANON



### ATTENTION

- Déchargez l'arme avant de nettoyer l'arme.
- N'enfoncez pas la bague de nettoyage violemment dans le canon, car elle pourrait l'endommager.
- Nettoyez les pièces métalliques extérieures à l'aide d'un chiffon doux préalablement imbibé d'huile pour armes.
- Ne versez jamais l'huile de silicone directement dans le canon.

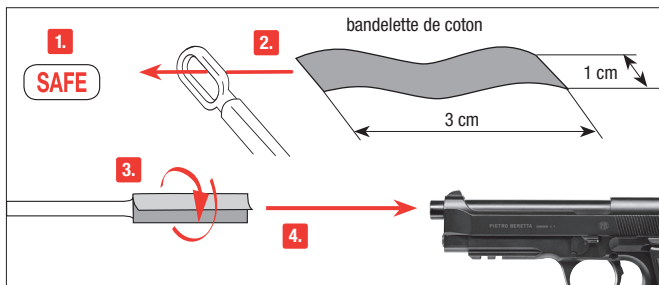

Mettez la sûreté de l'arme. Utilisez une tige fine d'une longueur d'env. 30 cm. Enroulez une bandelette de coton à son extrémité et nettoyez le canon avec une petite quantité d'huile de silicone.



## MANEJO SEGURO DE ARMAS

ES

Deberá estar familiarizado con el manejo correcto y seguro de su arma. Con respecto a las reglas básicas para disparar con seguridad, considere cada contacto con el arma como parte de su manejo.

- Trate el arma como si siempre estuviera cargada.
- Cargue siempre el arma con el seguro activado para evitar disparos involuntarios.
- Mantenga el dedo siempre fuera del gatillo y colóquelo solamente cuando vaya a disparar.
- Utilice únicamente proyectiles específicos para esta arma.
- Mantenga la boca del arma siempre en una dirección segura.
- Sólo está permitido disparar el arma en la vivienda del propietario o en las zonas de tiro autorizadas por la policía, siempre y cuando el proyectil no pueda llegar más allá del área de tiro. Para ello, tenga presente siempre la distancia máxima de peligro del proyectil.
- Nunca transporte el arma cargada. Cárguela solamente cuando tenga intención de disparar.
- Nunca apunte con el arma hacia personas o animales. Evite los disparos en los que el proyectil pueda rebotar: nunca dispare sobre superficies lisas y duras, ni al agua.
- Antes de disparar, asegúrese de que el objetivo y el entorno sean seguros.
- Antes de transportar el arma o de recibirla de manos de otra persona compruebe siempre que está descargada.
- Asegúrese de poder controlar la dirección hacia la que apunta la boca, aún en caso de tropiezo o de caída del arma.
- Por motivos de seguridad, cuando vaya a disparar póngase siempre gafas protectoras.
- Guarde el arma siempre descargada, separada de la munición y en lugar seguro para evitar que personas no aptas (personas sin formación, niños) puedan acceder a ella.
- Entregue esta arma, junto con las instrucciones de uso, únicamente a aquellas personas que:
  - estén perfectamente familiarizadas con el manejo de esta arma
  - hayan cumplido la edad mínima correspondiente fijada por la legislación en materia de armas del país respectivo.
- Cualquier modificación o reparación del arma deberá llevarla a cabo una empresa especializada o un armero.
- Nunca deje sin vigilancia un arma cargada.
- Siempre que entregue un arma a otra persona, asegúrese de que está descargada.

## REPARACIONES

Una arma que no funcione perfectamente es peligrosa. Es difícil reparar uno mismo un arma, y un ensamblaje incorrecto puede producir anomalías de funcionamiento peligrosas.

**Atención:** La comprobación y reparación del arma sólo pueden llevarla a cabo especialistas autorizados o un armero.



## INSTRUCCIONES DE SEGURIDAD | GARANTIA

ES



### ATENCIÓN

Por su propia seguridad y la de los demás, lea detenidamente las instrucciones de uso antes de disparar el arma por primera vez. Vendedores y compradores están obligados a cumplir con las normas de uso y posesión de armas de aire comprimido. Queda prohibida cualquier modificación de esta arma, ya que ello podría implicar un cambio en su clasificación legal. En caso de modificación quedaría extinguida de inmediato la garantía del fabricante.



### AVISO

No porte o muestre este arma de aire comprimido en público. Puede ser motivo de confusiones e ilegal. Miembros de las fuerzas de seguridad y la policía pueden tomarla por un arma de fuego real. No modifique el color ni los elementos identificativos para hacer que se parezca más a un arma de fuego real. Es peligroso y puede ser un delito

## GARANTIA

La empresa UMAREX se responsabiliza de reparar o sustituir su producto sin coste alguno en el plazo legalmente fijado a partir de la fecha de compra, siempre que el defecto no sea responsabilidad del propio usuario. Entregue el arma a un comerciante autorizado, describale el problema y adjunte el correspondiente comprobante de compra.

Las armas de aire comprimido de la empresa UMAREX Sportwaffen GmbH & Co. KG se fabrican de conformidad con las normas de homologación del Instituto Federal PTB (Physikalisch-Technischer Bundesanstalt), con la Ley Federal alemana, la normativa que establece el centro CIP y la experiencia en fabricación de armas de UMAREX Sportwaffen GmbH & Co. KG.

Por eso, no asumimos ninguna responsabilidad en el caso de que al exportar el arma a un país extranjero, ésta no cumpliera con la normativa legal local y el propietario o comprador tuviera que responder jurídicamente por dicho incumplimiento.

## DATOS TÉCNICOS

Número de artículo	2.5872 Mod. 92 A1	2.5975 Mod. 92 A1 Tactical
Sistema	Electric Airsoft	
Calibre/munición	cal. 6 mm BB	
Energía	< 0,5 JOULE	
Velocidad de disparo	hasta 60 m/s con BB 0,20 g	
Capacidad del cargador	30 BBs	
Gatillo	Acción simple	
Dispositivo visor	punto de mira y mira trasera fijos	
Seguro	manuell	
Peso	568 g	665 g
Longitud del cañón	125 mm	
Longitud	219 mm	
Länge mit Schalldämpferatrappe	-	345 mm
Distancia de peligro	150 m	



## DESIGNACION

ES





## SEGURO

ES



### ATENCIÓN

- Manipule la pistola sólo cuando esté asegurada.
- Procure que la boca apunte siempre en una dirección segura.



## PROBLEMAS



### Problemas

### Posibles causas

Problemas	Seguro activado	Cargador vacío	Cañón sucio	Temperaturas extremas	Munición errónea	Munición mal cargada	La corredera no está cerrada	La mira no está bien ajustada
Potencia de disparo deficiente		●	●	●	●	●		●
El arma no dispara	●	●			●	●	●	
Escasa velocidad de disparo		●	●	●	●	●		



## CARGA

ES



### ATENCIÓN

- En caso de que la batería esté vacía, pueden producirse daños en la caja de mando que necesitarán una reparación.
- No se deben descargar totalmente las baterías, ya que se podrían dañar los elementos.
- La sobrecarga duradera ocasiona averías permanentes en las baterías.
- Las baterías siempre deben estar descargadas antes de su carga.
- En las baterías no se ofrece ninguna garantía ya que se trata de piezas consumibles.



### ATENCIÓN



**Nota sobre las pilas:** No se puede exponer las pilas a un calor excesivo como la radiación solar, fuego o similares. Sólo se puede cargar las pilas recargables. Conforme a la legislación vigente no se puede tirar las pilas usadas a la basura doméstica. El usuario está obligado a llevarlas gratuitamente a un punto de recogida público para pilas usadas, un centro de ventas o al servicio técnico. Las pilas y baterías usadas contienen un alto porcentaje de sustancias reutilizables, denominado material reciclable. Al ser recuperado en el proceso de reciclaje, y no tirado a la basura, Usted contribuye a la conservación de importantes recursos y a proteger el medio ambiente contra los metales pesados tóxicos. Las pilas que contienen sustancias tóxicas están marcadas con un símbolo consistente en un cubo de basura tachado y el símbolo químico (Cd, Hg o Pb) del metal pesado responsable de su clasificación como pila tóxica. Por favor, infórmese en su municipio de los centros de eliminación respectivos. Las instrucciones para retirar las pilas figuran en el manual del producto. Relativo a las pilas primarias y secundarias a base de litio: Eliminar sólo las pilas totalmente descargadas. Si la pila no está totalmente descargada deberán tomarse precauciones para asegurarla contra un cortocircuito, p. ej. aislar los electrodos.

El tiempo de carga es de 2,25 h.

**Nota:** acumulador fijo (7,2 V / 300 mAh) con bloque de alimentación.



Presione el retén del cargador.  
Extraiga el cargador.



Introduzca el conducto como  
aparece en la imagen.





## LLENADO DEL CARGADOR

ES



### ATENCIÓN



Utilice únicamente bolas BB (que no presenten defectos) de calibre 6 mm.

No utilice en ningún caso los siguientes tipos de bolas BB:

① Diámetro superior a los 6 mm, ② Con cortes, ③ Con mitades que no coinciden, ④ Usadas o sucias. Si se utilizan proyectiles distintos de los apropiados, quedará anulada la garantía. Se recomienda el uso de bolas de precisión de la marca UMAREX/WALTHER. Para garantizar el buen funcionamiento del magazín, evite que la suciedad o el polvo entren en el mismo.



Presione el retén del cargador.  
Extraiga el cargador.

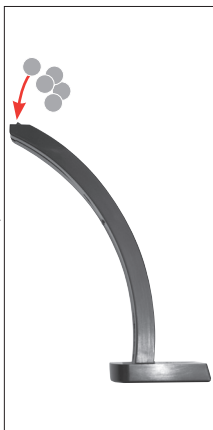

Cargar los BBs.



Introducir el cargador.





## MIRA

ES

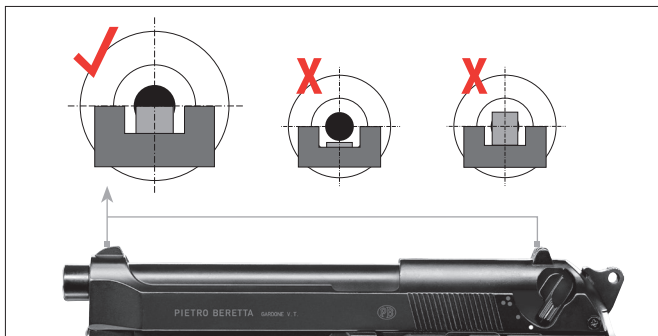

## DISPARO





## MONTAJE DE LOS ACCESORIOS

ES

### MONTAJE IMITACIÓN DE SILENCIADOR



Para montar la imitación de silenciador gire a la izquierda.



Para desmontar la imitación de silenciador gire a la derecha.



### LA LIMPIEZA DE CAÑÓN



#### ATENCIÓN

- Descargue el arma antes de limpiar el arma.
- No debe forzar la varilla de limpieza para introducirla dentro del cañón, porque podría dañar el arma.
- Limpie las piezas metálicas exteriores con un trapo suave, humedecido con aceite para armas.
- No vierta nunca aceite de silicona directamente dentro del cañón.

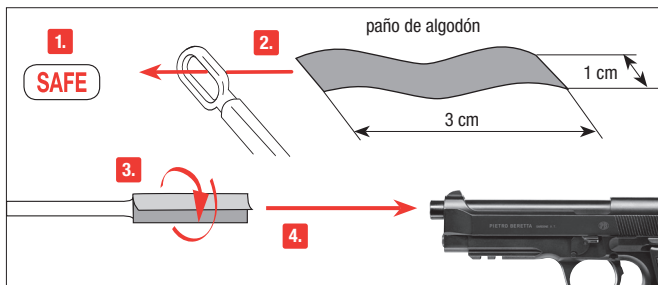

Asegure el arma. Coja una barra estrecha y larga de unos 30 cm. Enrolle un paño de algodón por el extremo, humedézcalo con un poco de aceite para armas y limpie el cañón con ayuda del mismo.



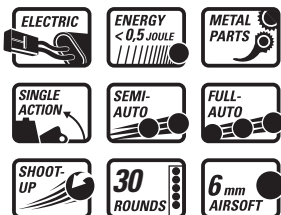

2.5872



2.5975



# UMAREX®

**UMAREX Sportwaffen GmbH + Co. KG**

Donnerfeld 2  
 59757 Arnsberg | Germany  
 Phone: +49 29 32 / 638-01  
 Fax: +49 29 32 / 638-222  
 verkauf@umarex.de | sales@umarex.de

[www.umarex.com](http://www.umarex.com)

Con riserva di modifiche di colore e di design, di miglioramenti tecnici, di errori di stampa e di sbagli. Tutte le informazioni senza garanzia.

We reserve the right to make color and design changes and technical improvements. No responsibility is accepted for printing errors or incorrect information.

Änderungen in Farbe und Design, sowie technische Verbesserungen, Druckfehler und Irrtum vorbehalten. Alle Angaben ohne Gewähr.

Sauf modifications de la couleur et du design ainsi que des améliorations techniques, erreurs d'impression et erreur. Toutes les données sont fournies sans garantie.

Salvo modificaciones de color y de diseño así como mejoramientos técnicos, erratas y error. Todos los datos sin garantía.

© UMAREX Sportwaffen GmbH & Co. KG